

CONDURA

WASHING MACHINE TWIN TUB

CWM8.5TTGT &
CWM10.5TTGT

CONDURA
KAYANG-KAYA!

CONTENTS

SAFETY INSTRUCTIONS

- Safety precautions 2

INSTALLATION

- Product description 5
- Unpacking the washing machine 5
- Installation area 6
- Change the position of the drain hose 6

OPERATIONS

- Control panel 7
- Preparation before washing 7
- Washing..... 7
- Rinse..... 8
- Spin..... 8
- Refer to the following table to select spinning time.... 8
- Reference of laundry quantity corresponding to different capacities... 8
- Laundry volume and detergent dosage reference..... 9
- Special functions..... 10

Maintenances

- Cleaning and Care 11
- Cleaning the cabinet..... 11
- Cleaning the inlet filter..... 11
- Operation when objects are dropped into the outside of the spin tub..... 12
- Trouble shooting..... 12
- Technical specifications..... 13

SAFETY INSTRUCTIONS

Safety precautions

For your safety, the information in this manual must be followed to minimize the risk of fire or explosion, electric shock, or to prevent property damage, personal injury or loss of life.

This appliance is not intended for use by persons (including children) with reduced physical, sensory or mental capabilities, or lack of experience and knowledge, unless they have been given supervision or instruction concerning use of the appliance by a person responsible for their safety. Children should be supervised to ensure that they do not play with the appliance.

If the supply cord is damaged, it must be replaced by the manufacturer, its service agent or similarly qualified persons in order to avoid a hazard.

The new hose-sets supplied with the appliance are to be used and that old hose-sets should not be reused.

The openings must not be obstructed by a carpet.

This appliance is intended to be used in household and similar applications such as:

- staff kitchen areas in shops, offices and other working environments;
- farm houses;
- by clients in hotels, motels and other residential type environments;
- bed and breakfast type environments;
- areas for communal use in blocks of flats.

SAFETY INSTRUCTIONS

Model	Wash rated capacity	Spin rated capacity	Maximum Water Pressure
CWM8.5TTGT	8.5 kg	5.0kg	0.6MPa
CWM10.5TTGT	10.5 kg	6.0kg	0.6MPa

Explanation of the symbols:



Warning!

This combination of symbol and signal word indicates a potentially dangerous situation which may result in death or serious injuries unless it's avoided.



Caution!

This combination of symbol and signal word indicates a potentially dangerous situation which may result in slight or minor injuries or damage to property and the environment.



Note!

This combination of symbol and signal word indicates a potentially dangerous situation which may result in slight or minor injuries.

SAFETY INSTRUCTIONS

Do not dismantle the machine by yourself.



Forbid dismantling

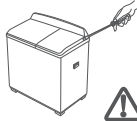

This appliance is for indoor use only. Do not install the machine in damp or rainy environment to avoid electric shock, fire, machine failure, or deformation. Do not spray water directly to the machine.

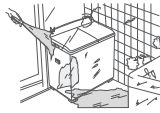

Do not place inflammable materials like burning candle, mosquito incense, cigaret etc. or heating source like electric stove, calorifier etc. on the machine. Do not let baby sit on it or place heavy things on it.

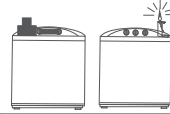

Do not wash clothes that are stained with kerosene, petrol, alcohol, and other flammable substance. Do not wash down-filled coat, raincoat or similar clothes.

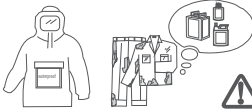

Make sure that the water inlet hose is connected and the tap is opened before washing. Do not exceed the max. water level to avoid water over flowing and machine failure.



Do not put finger into leaking hole on control panel in case of any harm. Do not put finger into rotation shaft position on control panel in case of any harm.



Do not let baby climb to the machine or play near running tub to avoid accident. Do not put hands into the tub before it stopping running.

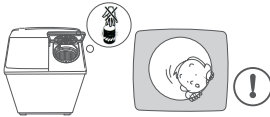

If use warm water, the water temperature should not exceed 50°C.

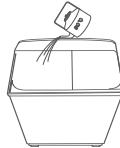

To avoid electric shock resulting from electric leakage, please connect grounding wire of the plug properly.

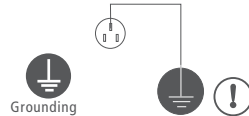

Wipe off dirty and dust on the plug often to prevent poor contact with power supply.



Do not insert or unplug the plug with wet hands to avoid electric shock.

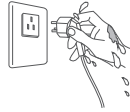

Do not replace power cord by yourself.



If the supply cord is damaged, it must be replaced by the manufacturer, its service agent or similarly qualified persons in order to avoid a hazard.

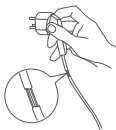

Insert the plug tightly when use. Unplug the plug from socket after use.

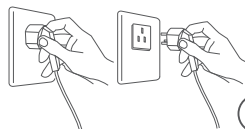

Do not pull the cord when unplug the plug.

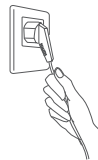

INSTALLATION

■ Product Description

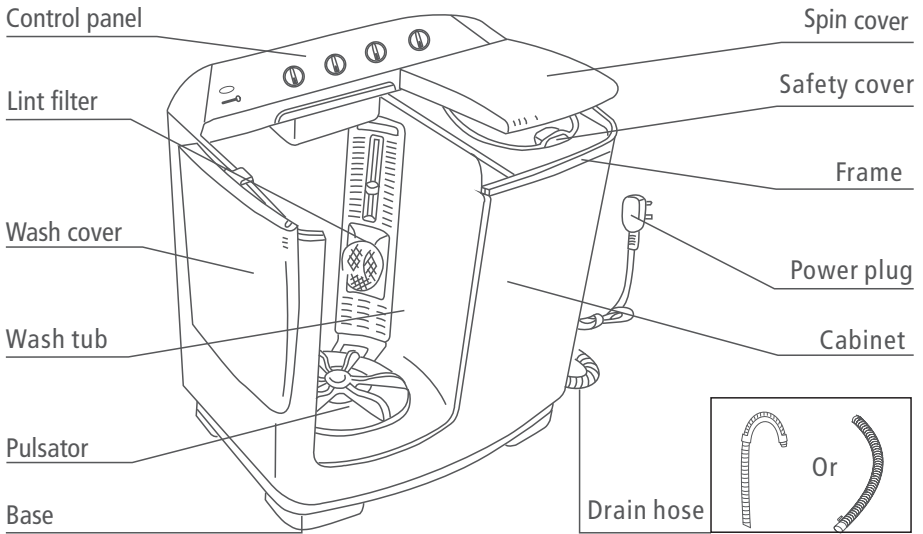

📌 Note!

- The product line chart is for reference only, please refer to real product as standard.

Accessories

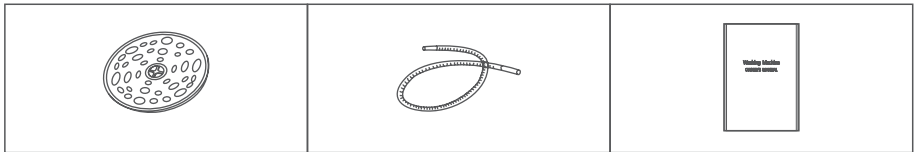

Inner spin cover

Water inlet hose

Manual

■ Unpacking the washing machine

⚠ Warning!

- Packaging material (e.g. Films, Styrofoam) can be dangerous for children.
- There is a risk of suffocation ! Keep all packaging well away from children.

1. Remove the cardboard box and styrofoam packing.
2. Lift the washing machine and remove the base packing.
3. Remove the tape securing the power supply cord and drain hose.
4. Remove the inlet hose from the drum.

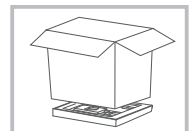

INSTALLATION

■ Installation area

⚠ Warning!

- Stability is important to prevent the product from wandering!
- Make sure that the product should not stand on the power cord.

Before installing the machine, the location characterized as follows shall be selected:

1. Rigid, dry, level surface and Avoid direct sunlight
2. Sufficient ventilation, Room temperature is above 0°C
3. Keep far away from the heat resources such as coal or gas.

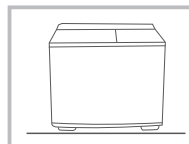
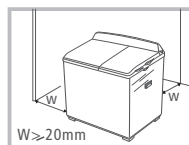

■ Change the position of the drain hose

The ex-factory installation position of the drain hose is located at the spin side. According to the installation site, the drain hose can also be installed at the wash side of the machine. The method is as follows:

1. Unplug the power cord and empty water in the drain hose completely.
2. Spread a piece of soft cloth on the floor (e.g. a blanket) and place the washing machine on it gently.
3. Take the drain hose out from the buckle at the spin side, and put it into the buckle at the wash side.
4. Hang up the drain hose kit.

There are two ways to place the end of drain hose:

1. For lower drain system

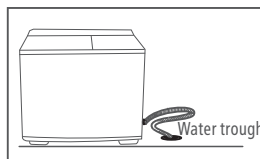
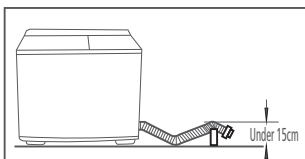
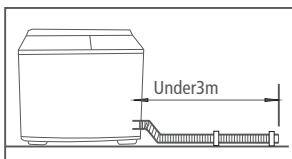

2. For upper drain system

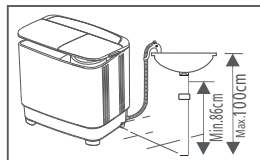
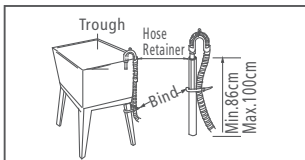
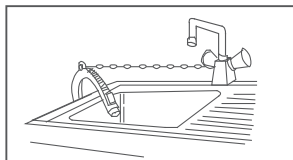

⚠ Warning!

- Do not kink or protract the drain hose.
- Position drain hose properly, otherwise damage might result of water leakage.
- If drain hose is too long, do not force it into machine as it will cause abnormal noises.

OPERATIONS

Control Panel

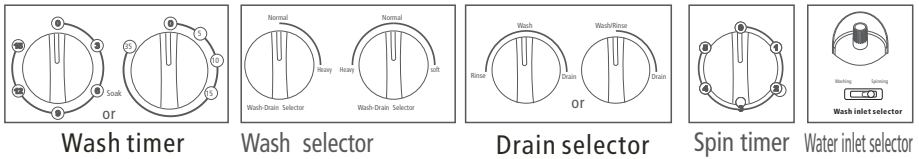

Note!

- The product line chart is for reference only, please refer to real product as standard.

- Wash timer: be used to select required washing time.
- Spin timer: be used to select required spinning time.
- Wash-Drain selector: For washing or rinsing, select " Normal " or " Heavy ". For draining ,select " Drain "
- Water inlet: be used to inject water..

Preparation Before Washing

Warning!

- The maximum gradient of the supporting surface for the washing machine should not exceed 2°
- Do not tear down electrical wires and components in the machine by yourself.
- There are holes on the base for ventilation. These holes should not be blocked by foreign objects (carpets, etc.).
- Never connect the grounding wire with the live wire, or it may lead to an electric shock.
- Check that there are no objects such as coins, hairpins, mud or sand in the pocket.
- Strings should be knotted in advance to prevent entanglement.
- Clothes can be classified for washing according to the texture, dirty degree and color.
- For small pieces (e.g., stockings) or fluffy clothes, put them into a nylon net for washing.

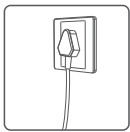

Plug in

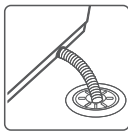

Put down the drain

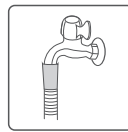

Open tap



Load and Close door

Washing



Open the door
Add detergent

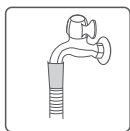

Arrived after the water
level, close the tap



Choose washing
function

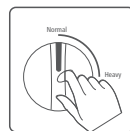

Choose washing
program

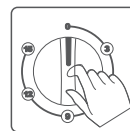

Choose washing
time

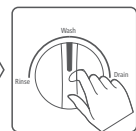

Drain

OPERATIONS

■ Rinse

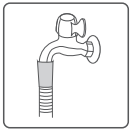

Open tap

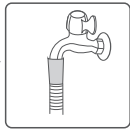

Arrived after the water level, close the tap

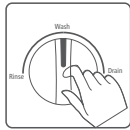

Choose washing function

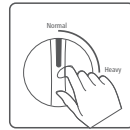

Choose washing program

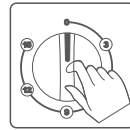

Choose washing time

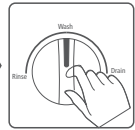

Drain

■ Spin



Shake out the laundry and put them into the spin tub.

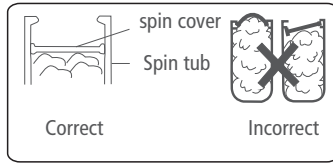

Put the inner spin cover on the laundry. Confirm the inner spin cover is placed horizontally.

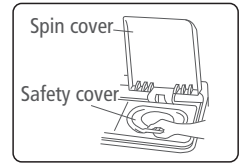

Close the safety cover and the spin cover.

■ Refer to the following table to select spinning time.

Washing materials	Silk	Light clothes (fiber/blended)	Knitwear (fiber)	Underwear (cotton)	Slipover (cotton/linen)	Toweling coverlet (cotton)
Spin time	About 50 seconds	About 1 minute	About 1-2 minutes	About 2-3 minutes	About 3-4 minutes	About 5 minutes

■ Reference of laundry quantity corresponding to different capacities

Laundry Capacity	Shirt about 500 g	Uniform about 650 g	Jeans about 900 g	Jacket about 1600 g
2.0kg Capacity	about 4 pcs.	about 3 pcs.	about 2 pcs.	about 1 pcs.
3.0kg Capacity	about 6 pcs.	about 4 pcs.	about 3 pcs.	about 1 pcs.
3.6kg Capacity	about 7 pcs.	about 5 pcs.	about 4 pcs.	about 2 pcs.
4.6kg Capacity	about 9 pcs.	about 6 pcs.	about 5 pcs.	about 2 pcs.
5.0kg Capacity	about 10 pcs.	about 7 pcs.	about 5 pcs.	about 3 pcs.
5.5kg Capacity	about 11 pcs.	about 8 pcs.	about 6 pcs.	about 3 pcs.
6.0kg Capacity	about 12 pcs.	about 9 pcs.	about 6 pcs.	about 3 pcs.
7.0kg Capacity	about 14 pcs.	about 10 pcs.	about 7 pcs.	about 4 pcs.
7.5kg Capacity	about 15 pcs.	about 11 pcs.	about 8 pcs.	about 4 pcs.
8.0kg Capacity	about 16 pcs.	about 12 pcs.	about 8 pcs.	about 5 pcs.
8.5kg Capacity	about 17 pcs.	about 13 pcs.	about 9 pcs.	about 5 pcs.
10.0kg Capacity	about 20 pcs.	about 15 pcs.	about 11 pcs.	about 6 pcs.
12.0kg Capacity	about 24 pcs.	about 18 pcs.	about 13 pcs.	about 7 pcs.
13.0kg Capacity	about 26 pcs.	about 20 pcs.	about 15 pcs.	about 8 pcs.
14.0kg Capacity	about 28 pcs.	about 22 pcs.	about 17 pcs.	about 9 pcs.
15.0kg Capacity	about 30 pcs.	about 24 pcs.	about 19 pcs.	about 10 pcs.
16.0kg Capacity	about 32 pcs.	about 26 pcs.	about 21 pcs.	about 11 pcs.
.....

OPERATIONS

■ Laundry Volume and Detergent Dosage Reference

8.5kg Capacity

Fabric type	Laundry capacity (kg)	Water level	Water flow	Wash time (minutes)	Detergent amount (g)
Synthetics, silk, Delicate fabrics	0-3.5 3.5-5.0	Low Mid	Normal	3 3-5	About 39 About 48
Cotton or linen	0-5.0 5.0-8.5	Mid High		7 7-10	About 48 About 63
Heavy soils	0-5.0	Mid	Heavy	10	About 48
	5.0-8.5	High		10-35(soak 20)	About 51

10.5kg Capacity

Fabric type	Laundry capacity (kg)	Water level	Water flow	Wash time (minutes)	Detergent amount (g)
Synthetics, silk, Delicate fabrics	0-5.0 5.0-6.5	Low Mid	Normal	3 3-5	About 50 About 61
Cotton or linen	0-6.5 6.5-10.5	Mid High		7 7-10	About 61 About 77
Heavy soils	0-6.5	Mid	Heavy	10	About 61
	6.5-10.5	High		10-35(soak 20)	About 77

MAINTENANCES

■ Cleaning And Care

⚠ Warning!

- Before your maintenance starts, please unplug the machine and close the tap.

■ Cleaning the cabinet

Proper maintenance on the washing machine can extend its working life. The surface can be cleaned with diluted non-abrasive neutral detergents when necessary. If there is any water overflow, use the wet cloth to wipe it off immediately. No sharp items are allowed.

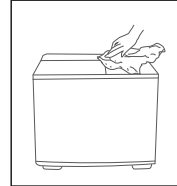

📌 Note!

- Formic acid and its diluted solvents or equivalent are forbidden, such as alcohol, solvents or chemical products, etc.

■ Cleaning the Inlet Filter

📌 Note!

- Inlet filter must be cleaned if there is less water.

Lint filter clean

1. Press the button head, and pull the lint filter out.
2. Turn the filter net inside out, and rinse it in water.
3. After inserting the claw, press the button to insert it into place.
4. A sound of "ba" means proper installation.

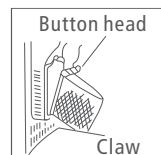

MAINTENANCES

3. Fit the water inlet hose and turn on the water tap to confirm water filling and draining work properly.

■ Operation When Objects Are Dropped Into the Outside of the Spin Tub

1. Remove all screws on the frame with a screw driver and loosen the connector of the brake belt .
2. Pull up the frame with both hands and turn it backwards.
3. Take out the clothes dropped into the outside of the spin tub.
4. Fasten the connector of the brake belt ,Press the frame to reset and tighten screws.

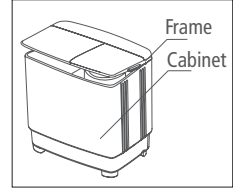

■ Trouble Shooting

If the Following Symptoms Occur, Please Disconnect The Power Plug And Perform The Following Checks:

Symptom	Reason
The washing machine does not work.	<ul style="list-style-type: none">● Check that the power supply is in good condition.● Check that the power plug is inserted properly.● Check that the wash timer knob or the spin timer knob is not in the "0" position.
The drain hose does not work.	<ul style="list-style-type: none">● Check that the drain hose is not laid too high.● Check that the drain hose is not frozen.● Check that the drain hose is not blocked by foreign matter.
There is abnormal noise during washing.	<ul style="list-style-type: none">● Check that there are no coins or any other foreign objects dropped into the wash tub.
There is abnormal noise and violent vibration during spinning.	<ul style="list-style-type: none">● Check that the washing machine is placed on flat, stable floor.● Check that clothes are evenly distributed in the spin tub.● Check that there are no washing materials or foaming debris dropped into the outside of the spin tub.

MAINTENANCES

■ Technical Specifications

Power Supply	Maximum Water Pressure	Maximum Time	Washing /spin level of noise
230V~,60Hz	0.6MPa	wash:15 min spin:5 min.	65/72 dB (A)

Model	Washing Capacity		Rated Power		Dimension W*D*H(mm)	Water volume H:/M:/L:(L)	Net Weight	Pump Rated Power
	Wash	Spin	Wash	Spin				
CWM8.5TTGT	8.5 kg	5.0kg	400W	135W	827X485X910	H1:70 H:65 M:53 L:41	22.5kg	—
CWM10.5TTGT	10.5 kg	6.0kg	480W	150W	870X515X975	H1:77 H:72 M:61 L:50	26.5kg	—

CONCEPCION DURABLES INCORPORATED
CUSTOMER SERVICE DEPARTMENT

308 Sen. Gil Puyat Avenue, Makati City

Trunk Line: 02 8 863 5555

Mobile Nos.: 0917 536 3030 (Globe)"SMS Only"

0947 996 2415 (Smart)"SMS Only"

P.O. BOX 211 COMMERCIAL CENTER
MAKATI CITY

BUSINESS REPLY
PERMIT No. 2416A
NO STAMP NEEDED

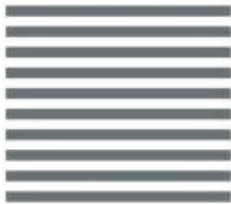

CONCEPCION DURABLES INCORPORATED

Online Service Booking Portal: condura.comsbooking.com

CUSTOMER SERVICE DEPARTMENT

GMA & LUZON Area

Address: 308 Sen. Gil Puyat Avenue, Makati City

Trunk Line: 02 8 863 5555

Mobile Number: +63 917 536 3030 (Globe) "SMS Only"

+63 947 996 2415 (Smart) "SMS Only"

Covered Region/Areas: National Capital Region (NCR), Ilocos Region (Region I), Cordillera Administrative Region (CAR), Central Luzon (Region III), CALABARZON (Region IV-A), MIMAROPA Except Romblon, Bicol

Email Address: customercare@condura.com

CEBU Regional Office

Address: Esperanza Bldg., AC Cortes St., Ibabao, Mandaue City Cebu

Landline: 032 328 1416 / 032 347 3380

Mobile Number: +63 947 996 2416

+63 999 887 1657

Covered Region/Area: Masbate, Central Visayas (Region VII), Eastern Visayas (Region VIII)

ILOILO Regional Office

Address: 277 Iznart St., Brgy Danao, City Proper, Iloilo City

Landline: 033 336 1121

Mobile Number: +63 947 996 2417

+63 919 072 6530

Covered Region/Area: Romblon, Western Visayas (Region VI)

CAGAYAN DE ORO Regional Office

Address: 102 CKY Center, Capistrano St. corner Chaves St., Cagayan de Oro City

Landline: 088 881 0615

Mobile Number: +63 947 996 2419

+63 939 253 5011

Covered Region/Area: Zamboanga Peninsula (Region IX), Northern Mindanao (Region X), Autonomous Region in Muslim Mindanao (ARMM) except Maguindanao, Agusan del Norte, Surigao del Norte

DAVAO Regional Office

Address: 1C, Nand-Saling Building, Sobrecary Street, Obrero, Davao City

Landline: 082 291 7276

Mobile Number: +63 947 996 2418

+63 998 965 6755

Covered Region/Area: Davao Region (Region XI), SOCCSKSARGEN (Region XII), Agusan del Sur, Surigao del Sur, Maguindanao

Fill-up this warranty card completely and mail within 15 days from date of purchase. This will activate your warranty from Condura!

CONDURA

MODEL NO.: _____ **SERIAL NO.:** _____
DEALER: _____ **BRANCH:** _____
DATE OF PURCHASE: _____ **DEALER INVOICE NO.:** _____
CUSTOMER NAME: _____ **EMAIL ADDRESS:** _____
ADDRESS: _____
TELEPHONE NO.: _____ **MOBILE NO.:** _____

I consent to the collection, processing and use by Concepcion Durables, Inc. (CDI) of the data above for the purposes identified in its Data Privacy Notice published on its website (www.condura.com), which is deemed incorporated into this Warranty Card.

CONDURA

PRODUCT WARRANTY CERTIFICATE

IMPORTANT: PLEASE READ CAREFULLY

Concepcion Durables, Inc. (CDI) warrants the purchaser, that this CONDURA washing machine will be free from defective material and workmanship, and agrees to repair, or at its discretion, replace any defective material with a new or equivalent part, through any of its Authorized Service Centers, only if found to be manufacturer's defect and in accordance with the terms of this warranty, subject to the following conditions:

1. **WARRANTY PERIOD** (from the date of original purchase)
2 years Motor warranty
1 year warranty on parts and labor

2. **LIMITATIONS**

This warranty is not transferable, valid only in the Philippines, and shall be null and void if the unit is damaged due to fire, improper use, abuse, neglect or accident; use with voltages beyond the allowable range of 216V to 244V; or failure to follow the operating instructions provided in the user's manual; if the serial number is removed or defaced; or if the unit has been tampered with, altered or in any way repaired, serviced or worked on by anyone other than a duly authorized representative or Service Center. This warranty does not cover plastic parts such as knobs, outer tub cover, hose, glass top cover lid and other consumable parts; any direct, indirect or consequential injury, loss or damage arising from the use or inability to use the unit; force majeure such as typhoon, flood, lightning, earthquake, etc., acts of God or any fortuitous events; if damaged due to rodents, pest, or related infestation; if damaged due to improper transport or subjected to rough handling.

Concepcion Durables, Inc. (CDI) offers this warranty as the only remedy available to the original purchaser for any defect that may arise within the warranty period. Correction of defects shall be considered as complete fulfillment of liabilities and responsibilities of CDI to the original purchaser. In no event shall CDI be held liable for any damage or consequence that may arise as a result of using this CONDURA product.

MODEL NUMBER: _____

SERIAL NUMBER: _____

NOTE: Keep this warranty card together with your Original Sales Invoice / Official Receipt as proof of purchase. If the date of purchase cannot be proven, warranty shall be based on CDI's invoice to Dealer.

CONDURA
KAYANG-KAYA!

www.condura.com