

# CONDURA

## WASHING MACHINE TWIN TUB

CONWM7.0TWTSASTD  
CONWM10TWTSASTD

# CONDURA

**KAYANG-KAYA!**

Pangarap ng Pamilya.  
**Alagang CONDURA**

# CONTENTS

---

## SAFETY INSTRUCTIONS

- Safety Precautions 2

## INSTALLATION

- Product description 5
- Unpacking the washing machine 5
- Installation area 6
- Position of the drain hose 6

## OPERATIONS

- Control panel 7
- Preparation before washing 7
- Washing 7
- Rinse 8
- Spin 8
- Laundry quantity with corresponding to  
different capacities 8
- Laundry volume and detergent dosage reference 9
- Special functions 9

## Maintenances

- Cleaning and Care 10
- Cleaning the cabinet 10
- Cleaning the inlet filter 10
- Anti-freezing protection 10
- Trouble shooting 11
- Technical specifications 12
- Energy efficiency test program 12
- Customer care
- Warranty Card

# SAFETY INSTRUCTIONS

---

## Safety precautions

- This appliance is not intended for use by persons (including children) with reduced physical, or mental capabilities, or lack of experience and knowledge, unless they have been given supervision or instruction concerning use of the appliance by a person responsible for their safety.
- Children should be supervised to ensure that they do not play with the appliance.
- If the supply cord is damaged, it must be replaced by the manufacturer, its service agent or similarly qualified persons in order to avoid a hazard.
- The new hose-sets supplied with the appliance are to be used and that old hose-sets should not be reused.
- The openings must not be obstructed by a carpet.
- This appliance is intended to be used in household and similar applications such as:
  - . staff kitchen areas in shops, offices and other working environments;
  - . farm houses;
  - . by clients in hotels, motels and other residential type environments;
  - . bed and breakfast type environments;
  - . areas for communal use in blocks of flats or in launderettes.

Model	Wash rated capacity	Spin rated capacity	Maximum Water Pressure
CONWM7.0TWTSASTD	7.0 kg	5.0 kg	0.6MPa
CONWM10TWTSASTD	10.0 kg	6.0 kg	0.6MPa

# SAFETY INSTRUCTIONS

---

## Explanation of the symbols:



### **Warning!**

This combination of symbol and signal word indicates a potentially dangerous situation which may result in death or serious injuries unless it's avoided.



### **Caution!**

This combination of symbol and signal word indicates a potentially dangerous situation which may result in slight or minor injuries or damage to property and the environment.



### **Note!**

This combination of symbol and signal word indicates a potentially dangerous situation which may result in slight or minor injuries.

# SAFETY INSTRUCTIONS

Do not dismantle the machine by yourself.

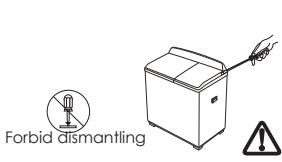

This appliance is for indoor use only. Do not install the machine in damp or rainy environment to avoid electric shock, fire, machine failure, or deformation. Do not spray water directly to the machine.

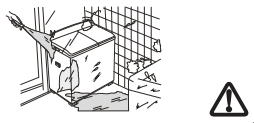

Do not place inflammable materials like burning candle, mosquito incense, cigarette etc. or heating source like electric stove, calorifier etc. on the machine. Do not let baby sit on it or place heavy things on it.



Do not wash clothes that are stained with kerosene, petrol, alcohol, and other flammable substance. Do not wash down-filled coat, raincoat or similar clothes.

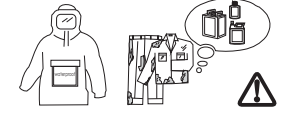

Make sure that the water inlet hose is connected and the tap is opened before washing.



Do not exceed the max. water level to avoid water overflowing and machine failure.



Do not let baby climb to the machine or play near running tub to avoid accident. Do not put hands in to the tub before it stopping running.

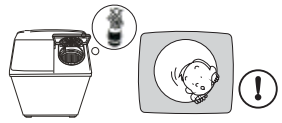

If using warm water, the water temperature should not exceed 50°C waterproof

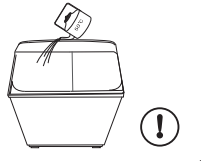

To avoid electric shock resulting from electric leakage, please connect grounding wire of the plug properly.

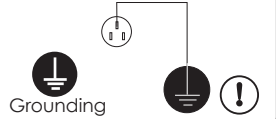

Wipe off dirt and dust on the plug often to prevent poor contact with power supply.



Do not insert or unplug the plug with wet hands to avoid electric shock.



Do not replace power cord by yourself.

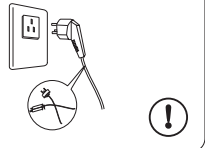

If the supply cord is damaged, it must be replaced by the manufacturer, its service agent or similarly qualified persons in order to avoid a hazard.

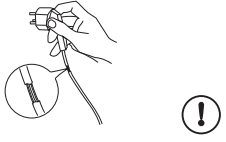

Insert the plug tightly when use. Unplug the plug from socket after use.

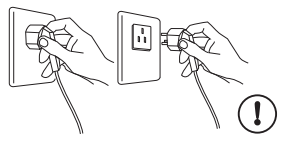

Do not pull the cord when unplugging the plug from the socket.

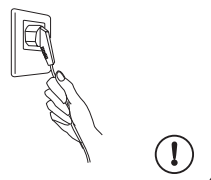

# INSTALLATION

## ■ Product Description

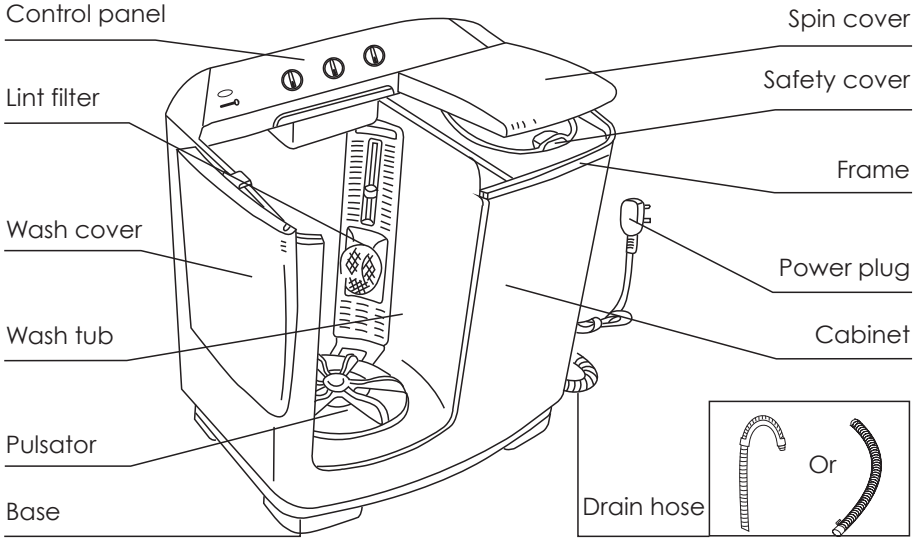

### 📌 Note!

- The product line chart is for reference only, please refer to real product as standard

## Accessories

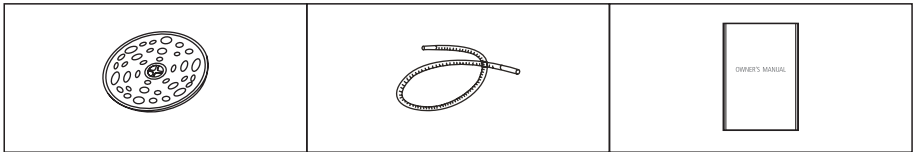

## ■ Unpacking the washing machine

### ⚠ Warning!

- Packaging material (e.g. Films, Styrofoam) can be dangerous for children.
- There is a risk of suffocation ! Keep all packaging well away from children.

1. Remove the cardboard box and styrofoam packing.
2. Lift the washing machine and remove the base packing.
3. Remove the tape securing the power supply cord and drain hose.
4. Remove the inlet hose from the drum.



# INSTALLATION

## ■ Installation area

### ⚠ Warning!

- Stability is important to prevent the product from
- Make sure that the product should not stand on the power cord.

Before installing the machine, the location characterized as follows shall be selected:

1. Rigid, dry, level surface and avoid direct sunlight
2. Sufficient ventilation, room temperature is above 0°C
3. Keep far away from the heat resources such as coal or gas.

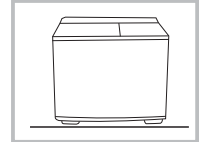
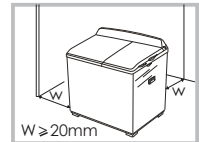

## ■ Change the position of the drain hose

The installation position of the drain hose is located the spin side.

According to the installation site, the drain hose can also be at the wash side of the machine. The method is as follows:

1. Unplug the power cord and empty water in the drain hose completely.
2. Spread a piece of soft cloth on the floor (e.g. a blanket) and place the washing machine on it gently.
3. Take the drain hose out from the buckle at the spin side, put it into the buckle at the wash side.
4. Hang up the drain hose kit.

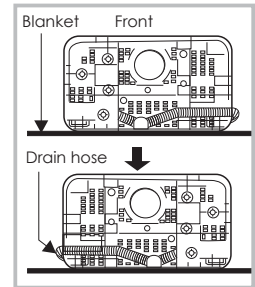

There are two ways to place the end of drain hose:

1. For lower drain system

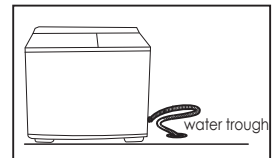
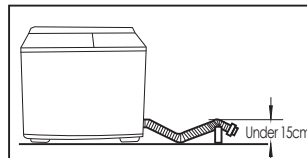
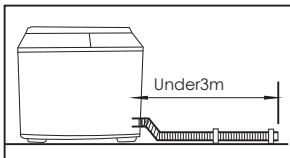

2. For upper drain system

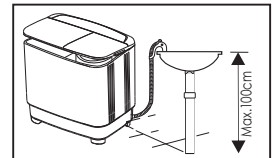
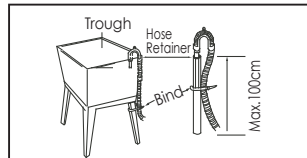
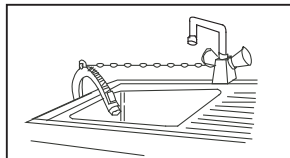

- Do not kink or protract the drain hose.
- Position drain hose properly, otherwise damage might result of water leakage.
- If drain hose is too long, do not force it into machine as it will cause abnormal noises.

# OPERATIONS

## ■ Control Panel

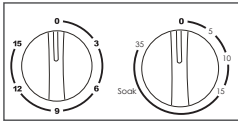

Wash timer

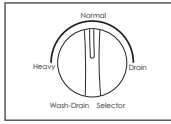

Drain selector

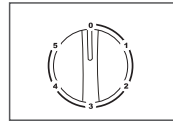

Spin timer

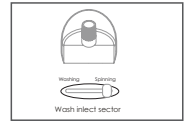

Water inlet selector

### 📌 Note!

- The product line chart is for reference only, please refer to real product as standard

- Wash timer: be used to select required washing time.
- Spin timer: be used to select required spinning time.
- Wash-Drain selector: For washing or rinsing, select " Normal" or " Heavy".  
For draining ,select "Drain"
- Water inlet: be used to inject water.

## ■ Preparation before washing

### ⚠ Warning!

- The maximum gradient of the supporting surface for the washing machine should not exceed 2°.
- Do not tear down electrical wires and components in the machine by yourself.
- There are holes on the base for ventilation. These holes should not be blocked by foreign objects (carpets, etc.).
- Never connect the grounding wire with the live wire, or it may lead to an electric shock.
- Check that there are no objects such as coins, hairpins, mud or sand in the pocket.
- Strings should be knotted in advance to prevent entanglement.
- Clothes can be classified for washing according to the texture, dirty degree and color.
- For small pieces (e.g., stockings) or fluffy clothes, put them into a nylon net for washing.

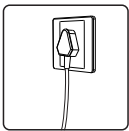

Wash timer

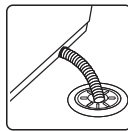

Put down the drain

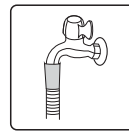

Open tap



load and Close door

## ■ Washing



Open the door  
Add detergent

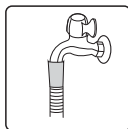

Close the tap after the  
water level

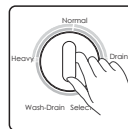

Choose washing  
program

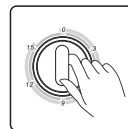

Choose the washing time  
To start washong clothes

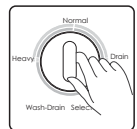

Drain



# OPERATIONS

## ■ Rinse

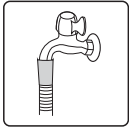

Open tap

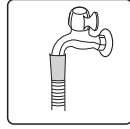

Close the tap after  
the water level

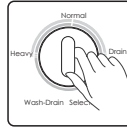

Choose washing  
program

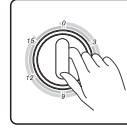

Choose the washing time  
To start washing clothes

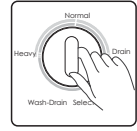

Drain

## ■ Spin



Shake out the laundry and  
put them into the spin tub.

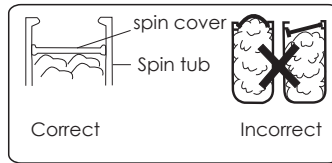

Put the inner spin cover on the laundry.  
Confirm the inner spin cover is placed  
horizontally.

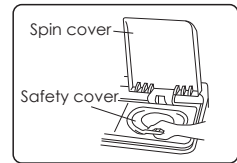

Close the safety cover  
and the spin cover.

## ■ Spinning time

Washing materials	Silk	Light clothes (fiber/blended)	Kintwaer (fiber)	Underwear (cotton)	Slipover (cotton)	Toweling coverlet (cotton)
Spin time	About 50 seconds	About 1 minute	About 1-2 minutes	About 2-3 minutes	About 3-4 minutes	About 5 minutes

## ■ Laundry quantity corresponding to different capacities

Laundry Capacity	Shirt	Uniform	Jeans	Jacket
2.0kg Capacity	about 4 pcs.	about 3 pcs.	about 2 pcs.	about 1 pc.
3.0kg Capacity	about 6 pcs.	about 4 pcs.	about 3 pcs.	about 1 pc.
3.6kg Capacity	about 7 pcs.	about 5 pcs.	about 4 pcs.	about 2 pcs.
4.6kg Capacity	about 9 pcs.	about 6 pcs.	about 5 pcs.	about 2 pcs.
5.0kg Capacity	about 10 pcs.	about 7 pcs.	about 5 pcs.	about 3 pcs.
5.5kg Capacity	about 11 pcs.	about 8 pcs.	about 6 pcs.	about 3 pcs.
6.0kg Capacity	about 12 pcs.	about 9 pcs.	about 6 pcs.	about 3 pcs.
7.0kg Capacity	about 14 pcs.	about 10 pcs.	about 7 pcs.	about 4 pcs.
7.5kg Capacity	about 15 pcs.	about 11 pcs.	about 8 pcs.	about 4 pcs.
8.0kg Capacity	about 16 pcs.	about 11 pcs.	about 8 pcs.	about 4 pcs.
8.5kg Capacity	about 17 pcs.	about 12 pcs.	about 9 pcs.	about 5 pcs.
10.0kg Capacity	about 20 pcs.	about 15 pcs.	about 10 pcs.	about 6 pcs.
12.0kg Capacity	about 24 pcs.	about 18 pcs.	about 13 pcs.	about 7 pcs.

# OPERATIONS

## ■ Laundry volume and detergent dosage reference

### 7.0kg Capacity

Fabric type	Laundry capacity (kg)	Water level	Water flow	Wash time (minutes)	Detergent amount (g)
Synthetics, silk,	0-3.0	Low	Normal	3	About 39
Delicate fabrics	3.0-5.0	Mid		3-5	About 51
Cotton or linen	0-5.0	Mid	Normal	7	About 51
Heavy soils	5.0-6.5/7.0	High		7-10	About 59
	0-5.0	Mid	Heavy	10	About 51
	5.0-6.5/7.0	High		10-35 (soak 20)	About 59

### 10.0kg Capacity

Fabric type	Laundry capacity (kg)	Water level	Water flow	Wash time (minutes)	Detergent amount (g)
Synthetics, silk,	0-5.0	Low	Normal	3	About 50
Delicate fabrics	5.0-6.5	Mid		3-5	About 61
Cotton or linen	0-6.5	Mid	Normal	7	About 61
Heavy soils	6.5-10.0	High		7-10	About 77
	0-6.5	Mid	Heavy	10	About 61
	6.5-10.0	High		10-35 (soak 20)	About 77

## ■ Special functions

For machines having the function only

### Soak function

For seriously stained clothes, soak wash is useful to achieve better wash result. 15-35 minutes of the wash timer is for soak wash:(illustrate as follows)



Total: 35 (mins) ■ Work time □ Static time

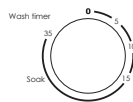

### Buzzer function

Function of the buzzer is to alarm finish of washing, and it is helpful to control wash process. Buzzer will alarm the completion of washing.

# MAINTENANCES

## ■ Cleaning and care

### ⚠ Warning!

- Before your maintenance starts, please unplug the machine and close the tap.

## ■ Cleaning the cabinet

Proper maintenance on the washing machine can extend its working life. The surface can be cleaned with diluted non-abrasive neutral detergents when necessary. If there is any water overflow, use the wet cloth to wipe it off immediately. No sharp items are allowed.

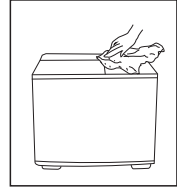

### 📌 Note!

- Formic acid and its diluted solvents are forbidden, such as solvents or chemical products, etc.

## ■ Cleaning the inlet filter

### 📌 Note!

- Inlet filter must be cleaned if there is less water.

Lint filter clean

1. Press the button head, and pull the lint filter out.
2. Turn the filter net inside out, and rinse it in water.
3. After inserting the claw, press the button to insert it into place.
4. A sound of "ba" means proper installation.

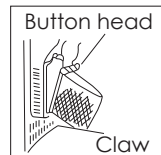

## ■ Anti-freezing protection

To prevent from freezing:

1. Turn off the water tap, remove the water inlet hose and empty water in the inlet hose completely.
2. Lay the drain hose and turn the drain selector knob to the "Drain" position to empty the water in the tub.

If the water is frozen, please take the following steps:

1. Put the water inlet hose into warm water of about 50°C
2. Keep about 2 liters of warm water below 50°C in the wash tub for about 10 minutes and then lay the drain hose and turn the wash drain selector knob to the "Drain" position to empty the water .



3. Fit the water inlet hose and turn on the water tap to confirm water filling and draining work properly.

## ■ Objects are dropped into the outside of the spin tub

1. Remove all screws on the frame with a screw driver and loosen the connector of the brake belt .
2. Pull up the frame with both hands and turn it backwards.
3. Take out the clothes dropped into the outside of the spin tub.
4. Fasten the connector of the brake belt, press the frame to reset and tighten screws.

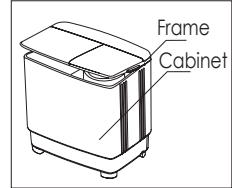

## ■ Trouble shooting

If the following symptoms occur, please disconnect the power plug and perform the following checks:

Symptom	Reason
The washing machine does not work.	<ul style="list-style-type: none"> <li>● Check that the power supply is in good condition.</li> <li>● Check that the power plug is inserted properly.</li> <li>● Check that the wash timer knob or the spin timer knob is not in the "0" position.</li> </ul>
The drain hose does not work.	<ul style="list-style-type: none"> <li>● Check that the drain hose is not laid too high.</li> <li>● Check that the drain hose is not frozen.</li> <li>● Check that the drain hose is not blocked by foreign matter.</li> </ul>
There is abnormal noise during washing.	<ul style="list-style-type: none"> <li>● Check that there are no coins or any other foreign objects dropped into the wash tub.</li> </ul>
There is abnormal noise and violent vibration during spinning.	<ul style="list-style-type: none"> <li>● Check that the washing machine is placed on flat, stable floor.</li> <li>● Check that clothes are evenly distributed in the spin tub.</li> <li>● Check that there are no washing materials or foaming debris dropped into the outside of the spin tub.</li> </ul>

# MAINTENANCES

---

## ■ Energy efficiency test program:

### **CONWM7.0TWSASTD and CONWM10TWSASTD**

During "Normal" Washing program, washing 6minutes;rinse once for 1minutes,and then spin twice, 6minutes each, Water level "M" used for all wash and rinse.

## ■ Technical Specification

Model	Washing Capacity	Dimension (W*D*Hmm)	Net Weight	Rated Power
CONWM7.0TWSASTD	7.0kg	761 x 448 x 905	19.5kg	380/135W
CONWM10TWSASTD	10.0kg	870 x 512 x - +(	25kg	450/150W

# CONCEPCION DURABLES INCORPORATED

## CUSTOMER SERVICE DEPARTMENT

308 Sen Gil Puyat Avenue, Makati City

Trunk Line: 02 8 863 5555

TOLL FREE: 1800 10 888 8888

Mobile Nos.: 0917 536 3030 (Globe) "SMS Only"  
0947 996 2415 (Smart) "SMS Only"

**BUSINESS REPLY  
PERMIT No. 2416A  
NO STAMP NEEDED**

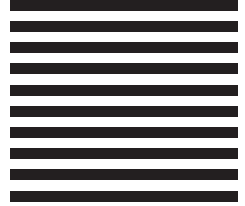

# CONCEPCION DURABLES INCORPORATED

## CUSTOMER SERVICE DEPARTMENT

GMA & LUZON Area

Address: 308 Sen. Gil Puyat Avenue, Makati City

Trunk Line: 02 8 863 5555

TOLL FREE: 1800 10 888 8888

Mobile Number: +63 917 536 3030 (Globe) "SMS Only"  
+63 947 996 2415 (Smart) "SMS Only"

Covered Region/Areas: National Capital Region (NCR), Ilocos Region (Region I), Cordillera Administrative Region (CAR), Central Luzon (Region III), CALABARZON (Region IV-A), MIMAROPA except Romblon (Region IV-B), Bicol Region except Masbate (Region V)  
Email Address: [customercare@condura.com](mailto:customercare@condura.com)

## CEBU Regional Office

Address: Dr. A Esperanza Building, A.C Cortes Ave. Mandaue City

Telefax No: ☎ 032 328 1416 / 032 347 3380

Mobile Number: +63 947 996 2416  
+63 921 222 0942

TOLL FREE: 1800 10 888 8888

Covered Region/Area: Masbate, Central Visayas (Region VII), Eastern Visayas (Region VIII)

## ILOILO Regional Office

Address: 109 Yulo Street, Brgy. Yulo-Arroyo, Iloilo City, Iloilo

Telefax No: 033 336 1121

Mobile Number: +63 947 996 2417  
+63 999 925 5736

TOLL FREE: 1800 10 888 8888

Covered Region/Area: Romblon, Western Visayas (Region VI)

## CAGAYAN DE ORO Regional Office

Address: No. 102 CKY Center, Capistrano-Chavez Street, CDO City

Telefax No: 088 881 0615

Mobile Number: +63 947 996 2419  
+63 939 253 5011

TOLL FREE: 1800 10 888 8888

Covered Region/Area: Zamboanga Peninsula (Region IX), Northern Mindanao (Region X), Autonomous Region in Muslim Mindanao (ARMM) except Maguindanao, Agusan del Norte, Surigao del Norte

## DAVAO Regional Office

Address: 1C, Nand-Saling Building, Sobrecarey Street, Obrero, Davao City

Telefax No: 082 291 7276

Mobile Number: +63 947 996 2418  
+63 922 294 1478

TOLL FREE: 1800 10 888 8888

Covered Region/Area: Davao Region (Region XI), SOCCSKSARGEN (Region XII), Agusan del Sur, Surigao del Sur, Maguindanao

Fill-out this warranty card completely and mail within 15 days from date of purchase. This will activate your warranty from Condura!

**CONDURA**

**MODEL NO.:** \_\_\_\_\_ **SERIAL NO.:** \_\_\_\_\_  
**DEALER:** \_\_\_\_\_ **BRANCH:** \_\_\_\_\_  
**DATE OF PURCHASE:** \_\_\_\_\_ **DEALER INVOICE NO.:** \_\_\_\_\_  
**CUSTOMER NAME:** \_\_\_\_\_ **EMAIL ADDRESS:** \_\_\_\_\_  
**ADDRESS:** \_\_\_\_\_  
**TELEPHONE NO.:** \_\_\_\_\_ **MOBILE NO.:** \_\_\_\_\_

I consent to the collection, processing and use by Concepcion Durables, Inc. (CDI) of the data above for the purpose identified in its Data Privacy Notice published in its website ([www.condura.com](http://www.condura.com)), which is deemed incorporated into this Warranty Card.

**CONDURA**

**PRODUCT WARRANTY CERTIFICATE**

**IMPORTANT: PLEASE READ CAREFULLY**

Concepcion Durables, Inc. (CDI) warrants the purchaser, that this CONDURA washing machine will be free from defective material and workmanship, and agrees to repair, or at it's discretion, replace any defective material with a new or equivalent part, through any of it's Authorized Service Centers, only if found to be manufacturer's defect and in accordance with the terms of this warranty, subject to the following conditions:

1. WARRANTY PERIOD (from the date of original purchase)
  - 5 years Motor warranty
  - 1 year warranty on parts and labor

2. LIMITATIONS

This warranty is not transferrable, valid only in the Philippines, and shall be null and void if the unit is damaged due to fire, improper use, abuse, neglect or accident; use with voltages beyond the allowable range of 216V to 244V; or failure to follow the operating instructions provided in the user's manual; if the serial number is removed or defaced; or if the unit has been tampered with, altered or in any way repaired, serviced or worked on by anyone other than a duly authorized representative or Service Center. This warranty does not cover plastic parts such as knobs, outer tub cover, hose and other consumable parts; any direct, indirect or consequential injury, loss or damage arising from the use or inability to use the unit; force majeure such as typhoon, flood, lightning, earthquake, etc., acts of God or any fortuitous events; if damaged due to rodents, pest, or related infestation; if damaged due to improper transport or subjected to rough handling. Concepcion Durables, Inc. (CDI) offers this warranty as the only remedy available to the original purchaser for any defect that may arise within the warranty period. Correction of defects shall be considered as complete fulfillment of liabilities and responsibilities of CDI to the original purchaser. In no event shall CDI be held liable for any damage or consequence that may arise as a result of using this CONDURA product.

MODEL NUMBER: \_\_\_\_\_ SERIAL NUMBER: \_\_\_\_\_

NOTE: Keep this warranty card together with your Original Sales Invoice / Official Receipt as proof of purchase. If the date of purchase cannot be proven, warranty shall be based on CDI's invoice to Dealer.

# CONDURA

**KAYANG-KAYA!**

**[www.condura.com](http://www.condura.com)**