

# CONDURA

## WASHING MACHINE TWIN TUB

CWM12.0TTGT



Pangarap ng Pamilya.  
**Alagang CONDURA**

# CONTENTS

---

## SAFETY INSTRUCTIONS

- Safety precautions ..... 2

## INSTALLATION

- Product description ..... 5
- Unpacking the washing machine ..... 5
- Installation area ..... 6
- Change the position of the drain hose ..... 6

## OPERATIONS

- Control panel ..... 7
- Preparation before washing ..... 7
- Washing..... 7
- Rinse..... 8
- Spin..... 8
- Refer to the following table to select spinning time.... 8
- Reference of laundry quantity corresponding to different capacities... 8
- Laundry volume and detergent dosage reference..... 9
- Special functions..... 10

## Maintenances

- Cleaning and Care ..... 11
- Cleaning the cabinet..... 11
- Cleaning the inlet filter..... 11
- Anti-freezing protection..... 11
- Operation when objects are dropped into the outside of the spin tub..... 12
- Trouble shooting..... 12
- Technical specifications..... 13

# SAFETY INSTRUCTIONS

---

## Safety precautions

For your safety, the information in this manual must be followed to minimize the risk of fire or explosion, electric shock, or to prevent property damage, personal injury or loss of life.

This appliance is not intended for use by persons (including children) with reduced physical, sensory or mental capabilities, or lack of experience and knowledge, unless they have been given supervision or instruction concerning use of the appliance by a person responsible for their safety. Children should be supervised to ensure that they do not play with the appliance.

If the supply cord is damaged, it must be replaced by the manufacturer, its service agent or similarly qualified persons in order to avoid a hazard.

The new hose-sets supplied with the appliance are to be used and that old hose-sets should not be reused.

The openings must not be obstructed by a carpet.

This appliance is intended to be used in household and similar applications such as:

- staff kitchen areas in shops, offices and other working environments;
- farm houses;
- by clients in hotels, motels and other residential type environments;
- bed and breakfast type environments;
- areas for communal use in blocks of flats or in launderettes.

# SAFETY INSTRUCTIONS

Model	Wash rated capacity	Spin rated capacity	Maximum Water Pressure
CWM12.0TTGT	12.0 kg	7.0kg	0.6MPa

## Explanation of the symbols:



### Warning!

This combination of symbol and signal word indicates a potentially dangerous situation which may result in death or serious injuries unless it's avoided.



### Caution!

This combination of symbol and signal word indicates a potentially dangerous situation which may result in slight or minor injuries or damage to property and the environment.



### Note!

This combination of symbol and signal word indicates a potentially dangerous situation which may result in slight or minor injuries.

# SAFETY INSTRUCTIONS

Do not dismantle the machine by yourself.



Forbid dismantling

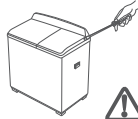

This appliance is for indoor use only. Do not install the machine in damp or rainy environment to avoid electric shock, fire, machine failure, or deformation. Do not spray water directly to the machine.

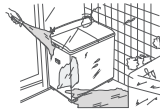

Do not place inflammable materials like burning candle, mosquito incense, cigaret etc. or heating source like electric stove, calorifier etc. on the machine. Do not let baby sit on it or place heavy things on it.

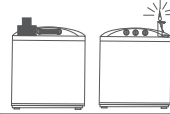

Do not wash clothes that are stained with kerosene, petrol, alcohol, and other flammable substance. Do not wash down-filled coat, raincoat or similar clothes.

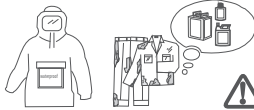

Make sure that the water inlet hose is connected and the tap is opened before washing. Do not exceed the max. water level to avoid water over flowing and machine failure.



Do not put finger into leaking hole on control panel in case of any harm. Do not put finger into rotation shaft position on control panel in case of any harm.



Do not let baby climb to the machine or play near running tub to avoid accident. Do not put hands into the tub before it stopping running.

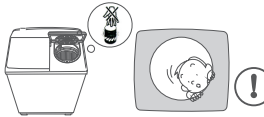

If use warm water, the water temperature should not exceed 50°C.

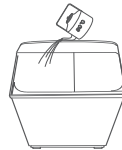

To avoid electric shock resulting from electric leakage, please connect grounding wire of the plug properly.

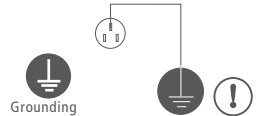

Grounding



Wipe off dirty and dust on the plug often to prevent poor contact with power supply.



Do not insert or unplug the plug with wet hands to avoid electric shock.

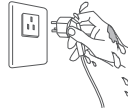

Do not replace power cord by yourself.



If the supply cord is damaged, it must be replaced by the manufacturer, its service agent or similarly qualified persons in order to avoid a hazard.

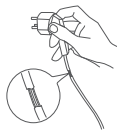

Insert the plug tightly when use. Unplug the plug from socket after use.

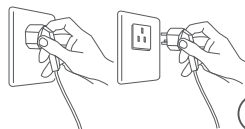

Do not pull the cord when unplug the plug.



# INSTALLATION

## ■ Product Description

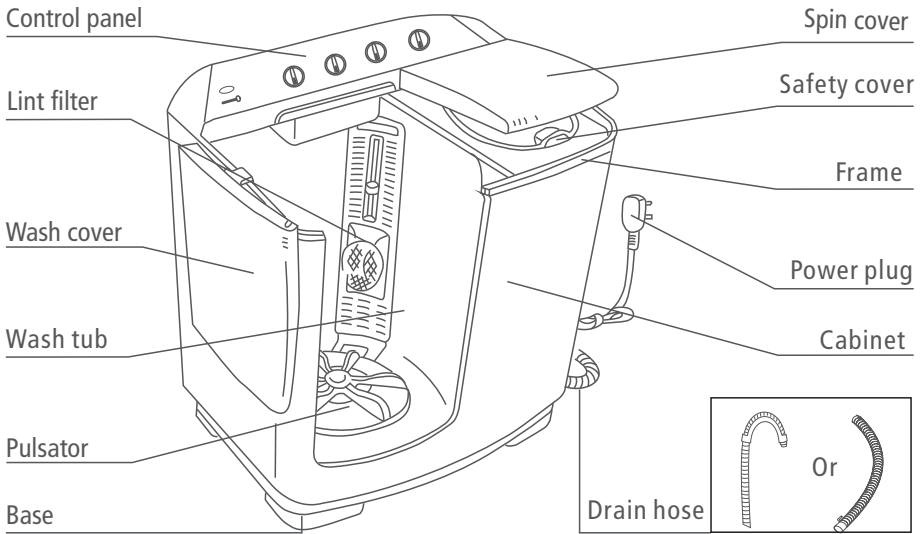

### 📌 Note!

- The product line chart is for reference only, please refer to real product as standard.

## Accessories

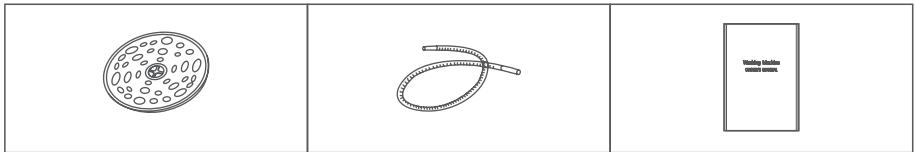

Inner spin cover

Water inlet hose

Manual

## ■ Unpacking the washing machine

### ⚠ Warning!

- Packaging material (e.g. Films, Styrofoam) can be dangerous for children.
- There is a risk of suffocation ! Keep all packaging well away from children.

1. Remove the cardboard box and styrofoam packing.
2. Lift the washing machine and remove the base packing.
3. Remove the tape securing the power supply cord and drain hose.
4. Remove the inlet hose from the drum.

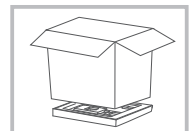

# INSTALLATION

## ■ Installation area

### ⚠ Warning!

- Stability is important to prevent the product from wandering!
- Make sure that the product should not stand on the power cord.

Before installing the machine, the location characterized as follows shall be selected:

1. Rigid, dry, level surface and Avoid direct sunlight
2. Sufficient ventilation, Room temperature is above 0°C
3. Keep far away from the heat resources such as coal or gas.

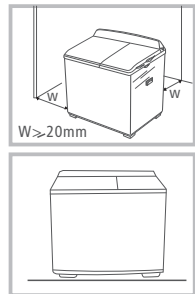

## ■ Change the position of the drain hose

The ex-factory installation position of the drain hose is located at the spin side. According to the installation site, the drain hose can also be installed at the wash side of the machine. The method is as follows:

1. Unplug the power cord and empty water in the drain hose completely.
2. Spread a piece of soft cloth on the floor (e.g. a blanket) and place the washing machine on it gently.
3. Take the drain hose out from the buckle at the spin side, and put it into the buckle at the wash side.
4. Hang up the drain hose kit.

There are two ways to place the end of drain hose:

### 1. For lower drain system

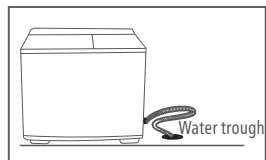
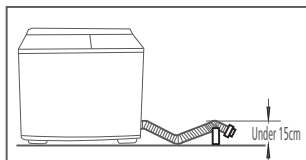
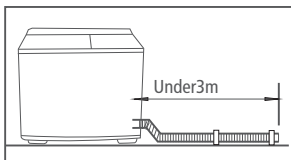

### 2. For upper drain system

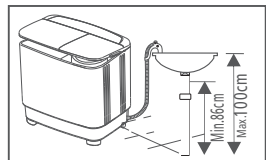
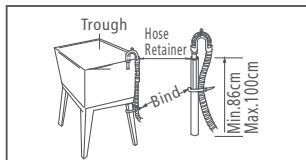
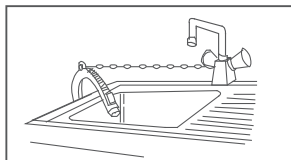

### ⚠ Warning!

- Do not kink or protract the drain hose.
- Position drain hose properly, otherwise damage might result of water leakage.
- If drain hose is too long, do not force it into machine as it will cause abnormal noises.

# OPERATIONS

## Control Panel

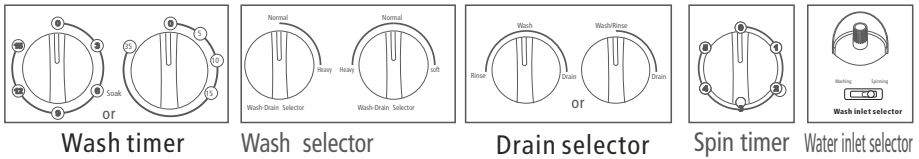

### Note!

- The product line chart is for reference only, please refer to real product as standard.

- Wash timer: be used to select required washing time.
- Spin timer: be used to select required spinning time.
- Wash-Drain selector: For washing or rinsing, select " Normal" or " Heavy" . For draining ,select " Drain"
- Water inlet: be used to inject water..

## Preparation Before Washing

### Warning!

- The maximum gradient of the supporting surface for the washing machine should not exceed 2°
- Do not tear down electrical wires and components in the machine by yourself.
- There are holes on the base for ventilation. These holes should not be blocked by foreign objects (carpets, etc.).
- Never connect the grounding wire with the live wire, or it may lead to an electric shock.
- Check that there are no objects such as coins, hairpins, mud or sand in the pocket.
- Strings should be knotted in advance to prevent entanglement.
- Clothes can be classified for washing according to the texture, dirty degree and color.
- For small pieces (e.g., stockings) or fluffy clothes, put them into a nylon net for washing.

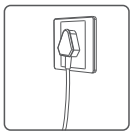

Plug in

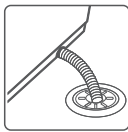

Put down the drain

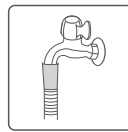

Open tap



Load and Close door

## Washing



Open the door  
Add detergent

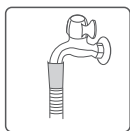

Arrived after the water  
level, close the tap

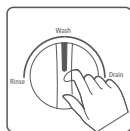

Choose washing  
function

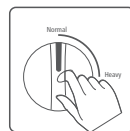

Choose washing  
program

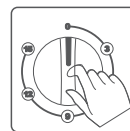

Choose washing  
time

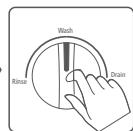

Drain



# OPERATIONS

## ■ Rinse

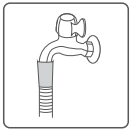

Open tap

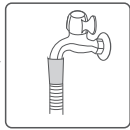

Arrived after the water level, close the tap

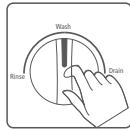

Choose washing function

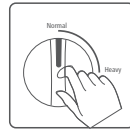

Choose washing program

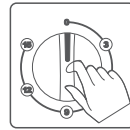

Choose washing time

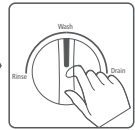

Drain

## ■ Spin



Shake out the laundry and put them into the spin tub.

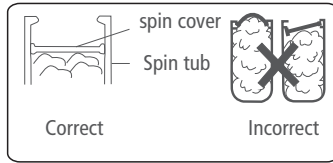

Put the inner spin cover on the laundry. Confirm the inner spin cover is placed horizontally.

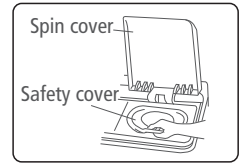

Close the safety cover and the spin cover.

## ■ Refer to the following table to select spinning time.

Washing materials	Silk	Light clothes (fiber/blended)	Knitwear (fiber)	Underwear (cotton)	Slipover (cotton/linen)	Toweling coverlet (cotton)
Spin time	About 50 seconds	About 1 minute	About 1-2 minutes	About 2-3 minutes	About 3-4 minutes	About 5 minutes

## ■ Reference of laundry quantity corresponding to different capacities

Laundry Capacity	Shirt about 500 g	Uniform about 650 g	Jeans about 900 g	Jacket about 1600 g
2.0kg Capacity	about 4 pcs.	about 3 pcs.	about 2 pcs.	about 1 pcs.
3.0kg Capacity	about 6 pcs.	about 4 pcs.	about 3 pcs.	about 1 pcs.
3.6kg Capacity	about 7 pcs.	about 5 pcs.	about 4 pcs.	about 2 pcs.
4.6kg Capacity	about 9 pcs.	about 6 pcs.	about 5 pcs.	about 2 pcs.
5.0kg Capacity	about 10 pcs.	about 7 pcs.	about 5 pcs.	about 3 pcs.
5.5kg Capacity	about 11 pcs.	about 8 pcs.	about 6 pcs.	about 3 pcs.
6.0kg Capacity	about 12 pcs.	about 9 pcs.	about 6 pcs.	about 3 pcs.
7.0kg Capacity	about 14 pcs.	about 10 pcs.	about 7 pcs.	about 4 pcs.
7.5kg Capacity	about 15 pcs.	about 11 pcs.	about 8 pcs.	about 4 pcs.
8.0kg Capacity	about 16 pcs.	about 12 pcs.	about 8 pcs.	about 5 pcs.
8.5kg Capacity	about 17 pcs.	about 13 pcs.	about 9 pcs.	about 5 pcs.
10.0kg Capacity	about 20 pcs.	about 15 pcs.	about 11 pcs.	about 6 pcs.
12.0kg Capacity	about 24 pcs.	about 18 pcs.	about 13 pcs.	about 7 pcs.
13.0kg Capacity	about 26 pcs.	about 20 pcs.	about 15 pcs.	about 8 pcs.
14.0kg Capacity	about 28 pcs.	about 22 pcs.	about 17 pcs.	about 9 pcs.
15.0kg Capacity	about 30 pcs.	about 24 pcs.	about 19 pcs.	about 10 pcs.
16.0kg Capacity	about 32 pcs.	about 26 pcs.	about 21 pcs.	about 11 pcs.
.....	.....	.....	.....	.....

# OPERATIONS

---

## ■ Laundry Volume and Detergent Dosage Reference

Fabric type	Laundry capacity (kg)	Water level	Water flow	Wash time (minutes)	Detergent amount (g)
Synthetics, silk, Delicate fabrics	0-4.5	Low	Normal	3	About 42
	4.5-8.0	Mid		3-5	About 65
Cotton or linen	0-8.0	Mid	Normal	7	About 65
	8.0-12.0	High		7-10	About 87
Heavy soils	0-8.0	Mid	Heavy	10	About 65
	8.0-12.0	High		10-35(soak 20)	About 87

# OPERATIONS

---

## ■ Special features

For machines having the function only

---

### Soak function

For seriously stained clothes, soak wash is useful to achieve better wash result. 15-35 minutes of the wash timer is for soak wash:(illustrate as follows)



Total: 35 (mins)     Work time     Static time

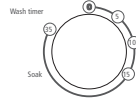

### Buzzer function

Function of the buzzer is to alarm finish of washing, and it is helpful to control wash process. Buzzer will alarm the completion of washing.

---

# MAINTENANCES

## ■ Cleaning And Care

### ⚠ Warning!

- Before your maintenance starts, please unplug the machine and close the tap.

## ■ Cleaning the cabinet

Proper maintenance on the washing machine can extend its working life. The surface can be cleaned with diluted non-abrasive neutral detergents when necessary. If there is any water overflow, use the wet cloth to wipe it off immediately. No sharp items are allowed.



### 📌 Note!

- Formic acid and its diluted solvents or equivalent are forbidden, such as alcohol, solvents or chemical products, etc.

## ■ Cleaning the Inlet Filter

### 📌 Note!

- Inlet filter must be cleaned if there is less water.

Lint filter clean

1. Press the button head, and pull the lint filter out.
2. Turn the filter net inside out, and rinse it in water.
3. After inserting the claw, press the button to insert it into place.
4. A sound of "ba" means proper installation.

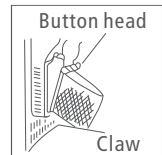

## ■ Anti-freezing Protection

To prevent from freezing:

1. Turn off the water tap, remove the water inlet hose and empty water in the water inlet hose completely.
2. Lay the drain hose and turn the drain selector knob to the "Drain" position to empty the water in the tub.

If the water is frozen, please take the following steps:

1. Put the water inlet hose into warm water of about 50°C.
2. Keep about 2 liters of warm water below 50°C in the wash tub for about 10 minutes and then lay the drain hose and turn the wash drain selector knob to the "Drain" position to empty the water.



# MAINTENANCES

---

3. Fit the water inlet hose and turn on the water tap to confirm water filling and draining work properly.

## ■ Operation When Objects Are Dropped Into the Outside of the Spin Tub

1. Remove all screws on the frame with a screw driver and loosen the connector of the brake belt .
2. Pull up the frame with both hands and turn it backwards.
3. Take out the clothes dropped into the outside of the spin tub.
4. Fasten the connector of the brake belt ,Press the frame to reset and tighten screws.

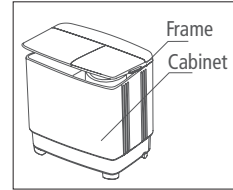

## ■ Trouble Shooting

If the Following Symptoms Occur, Please Disconnect The Power Plug And Perform The Following Checks:

Symptom	Reason
The washing machine does not work.	<ul style="list-style-type: none"><li>● Check that the power supply is in good condition.</li><li>● Check that the power plug is inserted properly.</li><li>● Check that the wash timer knob or the spin timer knob is not in the "0" position.</li></ul>
The drain hose does not work.	<ul style="list-style-type: none"><li>● Check that the drain hose is not laid too high.</li><li>● Check that the drain hose is not frozen.</li><li>● Check that the drain hose is not blocked by foreign matter.</li></ul>
There is abnormal noise during washing.	<ul style="list-style-type: none"><li>● Check that there are no coins or any other foreign objects dropped into the wash tub.</li></ul>
There is abnormal noise and violent vibration during spinning.	<ul style="list-style-type: none"><li>● Check that the washing machine is placed on flat, stable floor.</li><li>● Check that clothes are evenly distributed in the spin tub.</li><li>● Check that there are no washing materials or foaming debris dropped into the outside of the spin tub.</li></ul>

# MAINTENANCES

## ■ Technical Specifications

Power Supply	Maximum Water Pressure		Maximum Time		Washing /spin level of noise			
230V~,60Hz	0.6MPa		wash:15 min. spin:5 min.		68/72 dB (A)			

Model	Washing Capacity		Rated Power		Dimension W*D*H(mm)	Water volume H:/M:/L:(L)	Net Weight	Pump Rated Power
	Wash	Spin	Wash	Spin				
CWM12.0TTGT	12.0 kg	7.0kg	450W	180W	902*537*985	H:87 M:65 L:42	32.0kg	/

CELEBRATING  
35  
YEARS

**CONDURA**

---

IBA ANG PINOY

**[www.condura.com](http://www.condura.com)**